

Data Sheet



Article number: 0108053

Description: Retaining ring JK 36 DIN 984

Measures

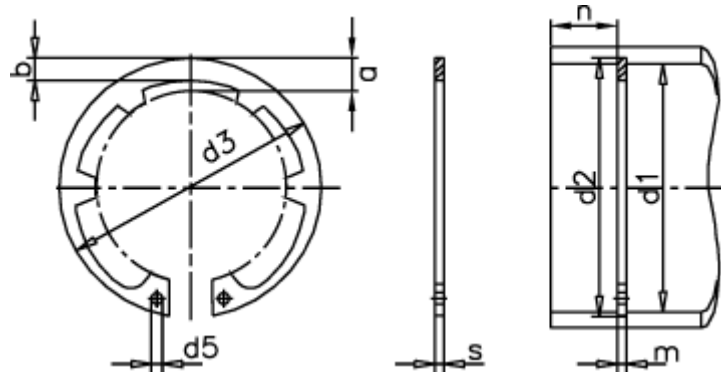

a max	= 5.6	FN kN	= 19.4	s	= 1.50
AN mm ²	= 116.0	FRg kN	= 6.4	t	= 1.00
b	= 3.6	FR kN	= 26.4	tol	= +0,25
d1	= 36	g	= 1.5	tol	= -0.06
d2	= 38.0	K kN-mm	= 50.2	tol	= +0,50-0,25
d3	= 38.8	m min	= 1.60	Tong	= ZGJ-2
d5 min	= 2.5	Nominal drive	= 3.0	Weight kg/1000	= 4.15
Description	= JK 36	Number of serrations	= 6		